

Article number: 2012421025

Description: E+G
Pin with axial lock GN 124.2-10-25

Measures

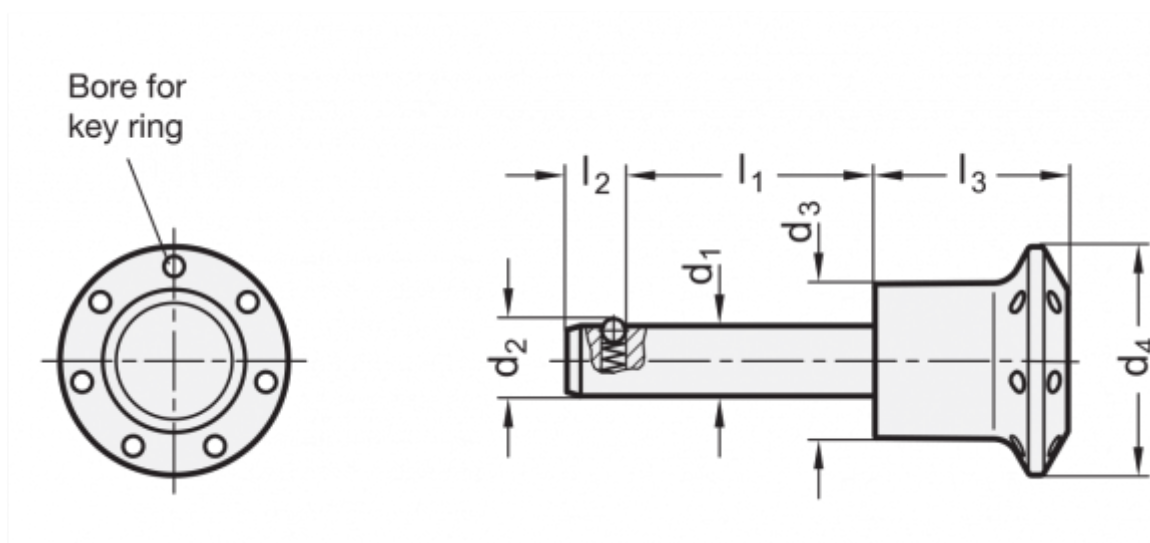

Axial grasping power on pins N = 30	= 30	$l_2 = 8.7$
Bore for pin D12	= 10	$l_3 = 27.0$
d1	= 10	
d2	= 12.0	
d3	= 18.5	
d4	= 31	
Dividing power (double) in kN	= 62	
l_1	= 25	